



"The Right Control for Your Application."

KB Electronics, Inc.

12095 NW 39 Street, Coral Springs, FL 33065-2516

Telephone: 954-346-4900; Fax: 954-346-3377

www.kbelectronics.com

# KBRG-240D (Part No. 8800), KBRG-225D (Part No. 8802), KBRG-255 (Part No. 8821) Installation and Operation Manual Supplemental Information

This supplement is for Models KBRG-240D, KBRG-225D, and KBRG-255 Installation and Operation Manuals (Part Nos. A40260 and A40287) until the new manuals are available. The manuals must be read and understood before operating these controls. For further assistance, contact our Sales Department at 954-346-4900 or Toll Free at 800-221-6570 (outside Florida).

### These Controls have been Converted to Surface Mount Technology (SMT)

The OFFSET and TCL trimpots have been moved to be aligned with the other trimpots. The General Performance Specifications, Electrical Ratings, Mechanical Specifications, and Connection Diagrams have not changed. The Parts Lists and Schematics in the manuals no longer apply to these controls and should not be used. See Figure 1, below, for Models KBRG-225D and KBRG-240D Logic Board's Trimpot and Jumper location changes. See Figure 2, on page 2, for Model KBRG-255 Logic Board's Trimpot and Jumper location changes.

**Figure 1**  
**Models KBRG-225D and KBRG-240D Logic Board Layout**

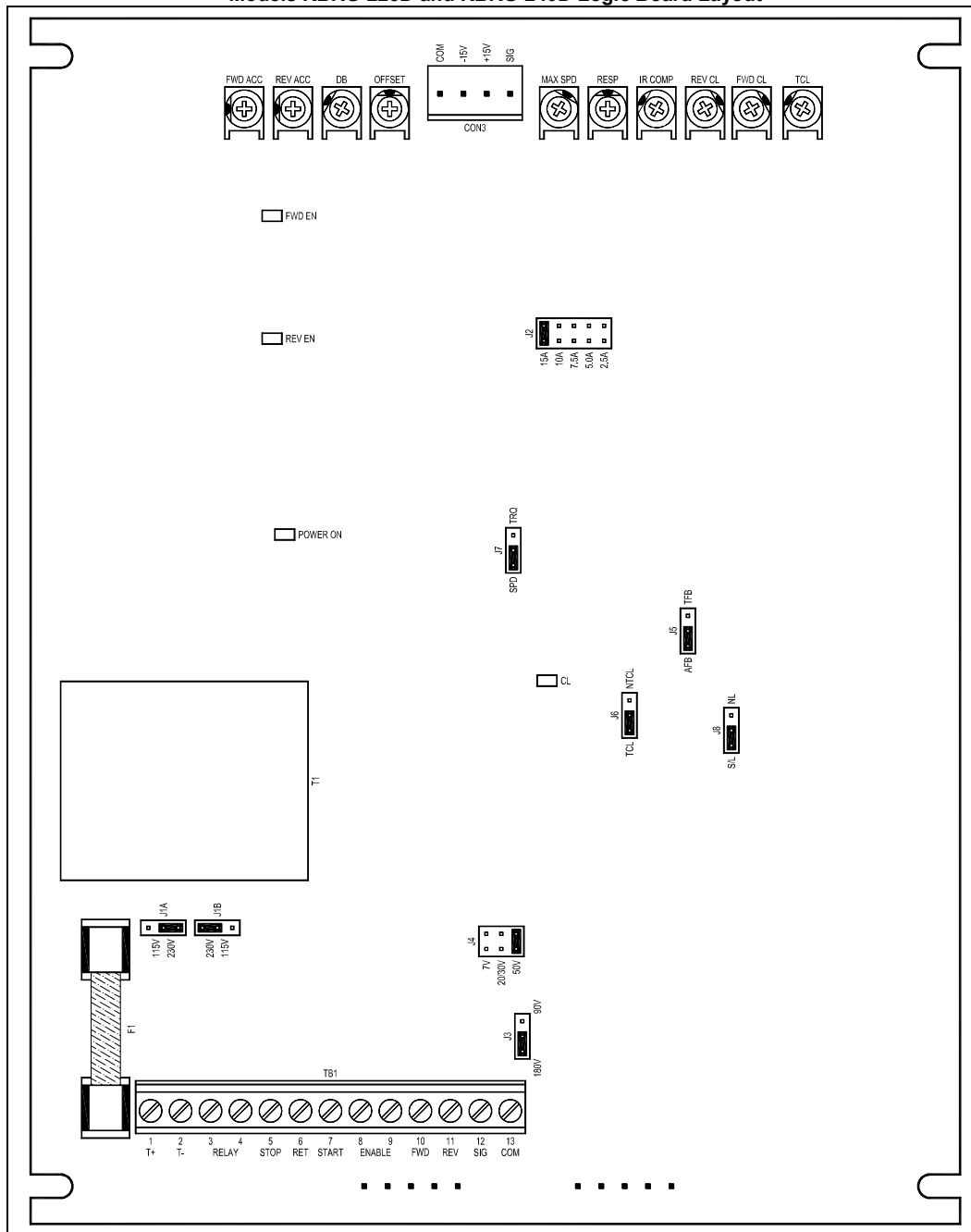



"The Right Control for Your Application."

KB Electronics, Inc.

12095 NW 39 Street, Coral Springs, FL 33065-2516

Telephone: 954-346-4900; Fax: 954-346-3377

www.kbelectronics.com

**KBRG-240D (Part No. 8800), KBRG-225D (Part No. 8802), KBRG-255 (Part No. 8821)  
Installation and Operation Manual Supplemental Information**

**Figure 2  
Model KBRG-255 Logic Board Layout**

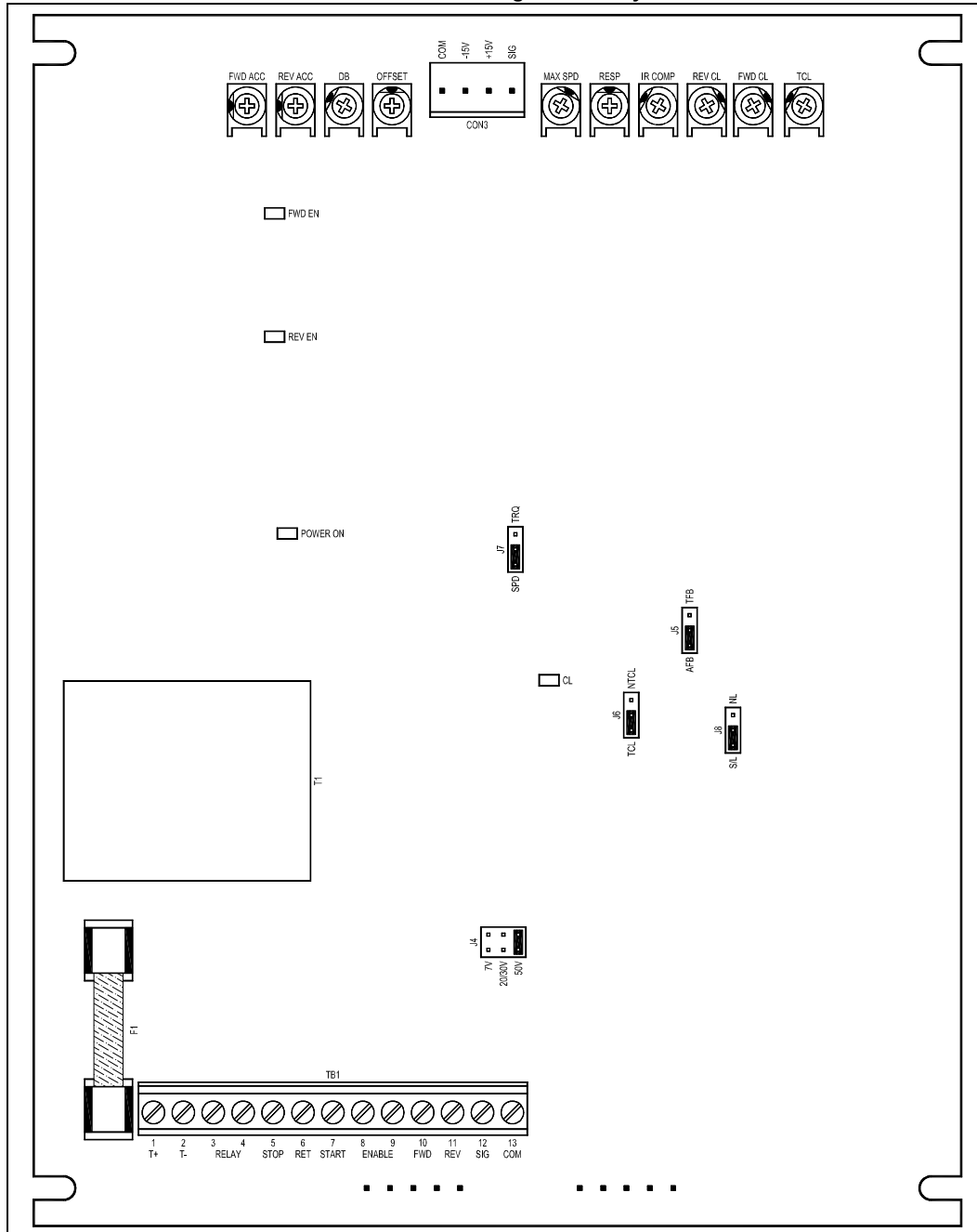

# INSTALLATION AND OPERATING INSTRUCTIONS

## REGENERATIVE DRIVE

MODEL KBRG-255 (5HP)

KB Part No. 8821

### FULL WAVE • 4 QUADRANT

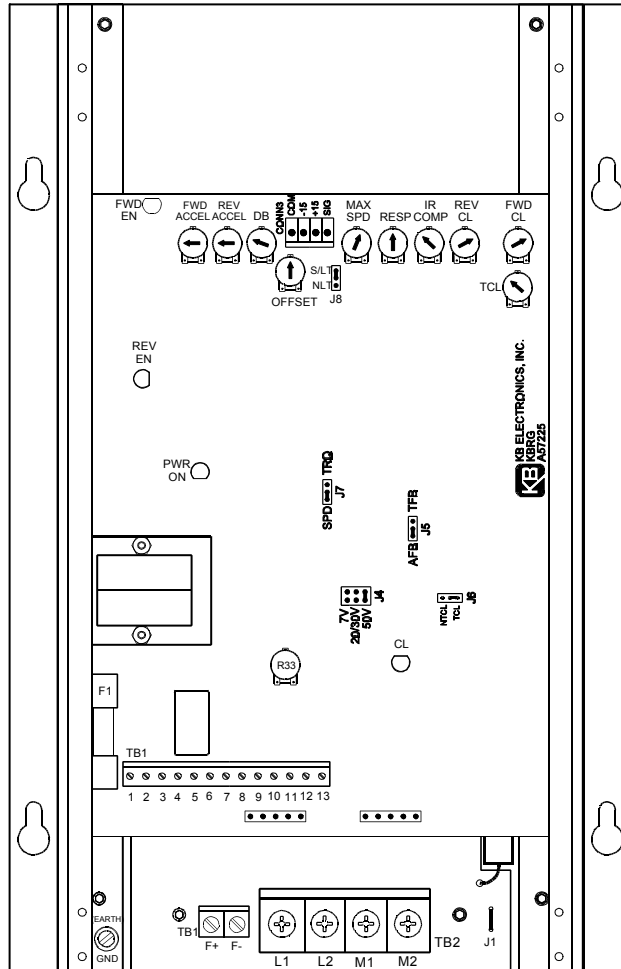

 **See Safety Warning on Page 1**

The information contained in this manual is intended to be accurate. However, the manufacturer retains the right to make changes in design which may not be included herein.

# PENTA **KB** POWER™

A COMPLETE LINE OF MOTOR DRIVES

## TABLE OF CONTENTS

<u>Section</u>	<u>Page</u>
i. Simplified Setup and Operating Instructions . . . . .	1
ii. Safety Warning . . . . .	1
I. General Information . . . . .	2
II. Setting Mode of Drive (Speed or Torque Control) . . . . .	4
III. Setting Selectable Jumpers . . . . .	5
IV. Mounting . . . . .	6
V. Wiring . . . . .	6
VI. Fusing . . . . .	10
VII. Operation . . . . .	10
VIII. Trimpot Adjustments . . . . .	11
IX. Function Indicator Lamps . . . . .	13
X. Limited Warranty . . . . .	20

### TABLES

1. Electrical Ratings . . . . .	2
2. General Performance Specifications . . . . .	2
3. Summary of Control Operation . . . . .	4
4. Terminal Block Wiring Information . . . . .	7
5. Field Connections . . . . .	7
6. Control State vs Relay Contact State . . . . .	10
7. Current Limit Timer Settings . . . . .	13
8. Parts List (Power Board) . . . . .	13
9. Parts List (Logic Board) . . . . .	15, 16

### FIGURES

1. Control Layout . . . . .	3
2A. Linear Torque Curve . . . . .	5
2B. Non-Linear Torque Curve . . . . .	5
3. AC Line and Armature Connection . . . . .	7
4A. Full Voltage Field . . . . .	7
4B. Half Voltage Field . . . . .	7
5. Mechanical Specifications . . . . .	8
6. Main Speed Potentiometer Connections . . . . .	9
7A. Voltage Following . . . . .	9
7B. Enable . . . . .	10
7C. Start/Stop Circuit . . . . .	10
7D. Alarm Contacts . . . . .	10
7E. Tach-generator Connection. . . . .	10
8. Accel Trimpot Adjustment . . . . .	11
9. Offset Trimpot Adjustment . . . . .	11
10. Deadband Trimpot Adjustment . . . . .	11
11. Power Board Schematic . . . . .	24
12. Logic Board Schematic . . . . .	17

i.  **KBRG-255 SIMPLIFIED OPERATING INSTRUCTIONS**

**IMPORTANT** – You must read these simplified operating instructions before you proceed. These instructions are to be used as a reference only and are not intended to replace the detailed instructions provided herein. You must read the Safety Warning before proceeding.

**1. CONNECTIONS.**

**A. AC Line** – Wire AC line voltage (230VAC  $\pm$ 10%, 50/60 Hz). Connect ground wire (earth) to green ground screw.

**B. Motor.**

1. Permanent Magnet (PM Type). Connect motor armature leads to M1+ and M2-.
2. Shunt Wound Motors. Connect motor armature as above. Connect full voltage shunt field wires (180 volt motors with 200 volt fields) to F+ and F-. Connect half voltage field wires (180 volt motors with 100 volt fields) to F+ and L1.

**2. SPEED OR TORQUE MODE.**

Jumper J7 is factory set for speed control operation (SPD). For torque control, set J7 to TRQ position. Note: J8 must be set to “S/LT” position for speed control operation.

**3. TRIMPOT SETTINGS.**

All trimpots have been factory set in accordance with figure 1, page 3.

**4. FUSING.**

The KBRG-255 does not contain AC line or armature fusing. It is recommended that a 40 Amp fuse or circuit breaker be installed on each AC line conductor not at ground potential. Do not fuse ground or neutral wires.

**5. SIGNAL INPUT.**

Connect potentiometer or **isolated** analog input to terminal “10,” “11,” “12” and “13” according to section V, E and F, on pages 7 and 9. Do not ground (earth) signal inputs. Use a signal isolator when controlling multiple drives from a non isolated signal source.



ii. **SAFETY WARNING! — PLEASE READ CAREFULLY**

This product should be installed and serviced by a qualified technician, electrician or electrical maintenance person familiar with its operation and the hazards involved. Proper installation, which includes wiring, mounting in proper enclosure, fusing or other overcurrent protection and grounding, can reduce the chance of electric shocks, fires or explosion in this product or products used with this product, such as electric motors, switches, coils, solenoids and/or relays. Eye protection must be worn and insulated adjustment tools must be used when working with control under power. This product is constructed of materials (plastics, metals, carbon, silicon, etc.) which may be a potential hazard. Proper shielding, grounding and filtering of this product can reduce the emission of radio frequency interference (RFI) which may adversely affect sensitive electronic equipment. If information is required on this product, contact our factory. It is the responsibility of the equipment manufacturer and individual installer to supply this safety warning to the ultimate user of this product. (SW effective 11/92)

This control contains electronic Start/Stop and Inhibit circuits that can be used to start and stop the control. However, these circuits are never to be used as safety disconnects since they are not fail-safe. Use only the AC line for this purpose.

The input circuits of this control (potentiometer, start/stop, Inhibit) are not isolated from AC line. **Be sure to follow all instructions carefully. Fire and/or electrocution can result due to improper use of this product.**

**CE** This product complies with all CE directives pertinent at the time of manufacture. Contact factory for detailed installation instructions and Declaration of Conformity. Installation of a CE approved RFI filter is required. Additional shielded motor cable and/or AC line cables may be required along with a signal isolator (SI-4X, KB P/N 8801 or equivalent).

**I. GENERAL INFORMATION.**

The KBRG-255 is a full-wave regenerative control, capable of operating a DC motor (Permanent Magnet or Shunt) in a bidirectional mode. It provides 4-quadrant operation which allows forward and reverse torque in both speed directions. The drive offers excellent controllability, which closely approximates the performance of servo-type drives. Ratings and specifications are presented in tables 1 and 2. Be sure the drive is used within these ratings and specifications.

**(Note: Regenerative drives normally produce more motor heating than standard unidirectional SCR speed controls, especially under low speed operation. This should be taken into consideration when specifying motor rating.)**



**WARNING!** Be sure to follow all instructions carefully. Fire or electrocution can result due to improper use of this product. Read Safety Warning.

**TABLE 1 – ELECTRICAL RATINGS**

Model	Part No.	Input Voltage (VAC)	Max. AC Current (RMS)	Output Voltage (VDC)	Max. DC Output Current (ADC)	Max. Horsepower HP, (KW)
KBRG-255	8821	230	38	0 – ±180	25	5, (3.8)

**TABLE 2 – GENERAL PERFORMANCE SPECIFICATIONS**

Parameter	Specification	Factory Setting
AC Line Input Voltage (VAC ±10%, 50/60 Hz)	230	230
AC Line Frequency (Hz), # of Phases	50/60, 1	—
Arm Voltage Range at 230VAC Line (VDC)	0 – ±180	0 – ±180
Field Voltage at 230VAC Line (VDC)	200/100	—
Service Factor	1.0	—
Duty	Continuous	—
Max Load Capacity (% for 2 minutes)	150	—
Ambient Temperature Range (°C)	0 – 50 <sup>(1)</sup>	—
Speed Range (Ratio)	50:1	—
Arm Feedback Load Regulation (% Base Speed)	±1	—
Tach Feedback Load Regulation (% Set Speed)	±1	—
Line Regulation (% Base Speed)	±0.5	—
FWD and REV Accel Range (Secs.)	0.1 – 15	1
Dead Band Range (% Base Speed)	0 – ±3	0
Max Speed Trimpot Range (% Base Speed)	70 – 110	100
IR Comp Range at 230VAC Line (VDC)	0 – 30	10
FWD and REV CL Range (%)	0 – 200	150
Timed CL Range (Sec.)	1 – 15	5
Voltage Following Input Range (VDC)	0 – ±10, 0 – ±15	0 – ±15
Voltage Following Linearity (% Base Speed)	±0.5	—
Tach-generator Voltage input (volts)	7, 20/30, 50	50

**Notes:** Control mounted with colling fins in vertical position. Maximum ambient temperature in horizontal position is 45 °C.

FIG. 1 – CONTROL LAYOUT

Illustrates Factory Setting of Jumpers and Approximate Trimpot Settings

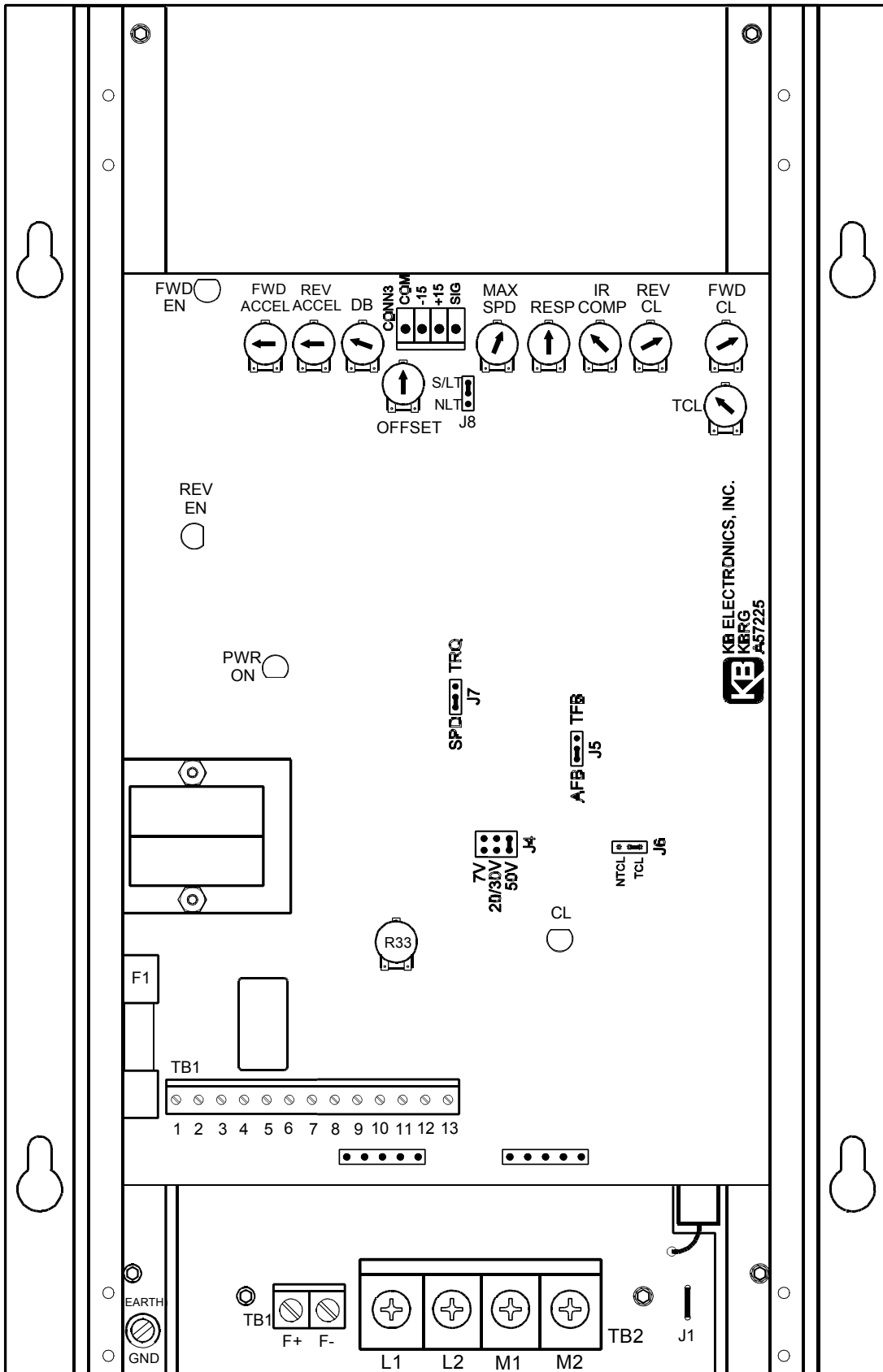

**II. SETTING MODE OF DRIVE (SPEED OR TORQUE CONTROL).**

The KBRG-255 can be operated as a speed control or torque control by setting the position of jumper J7. The main speed potentiometer controls the magnitude of the mode selected. Set jumper J7 to "SPD" for speed control or to "TRQ" for torque control. (See fig. 1, p. 3.)

- A. Speed Control Mode** – When jumper J7 is set to the "SPD" position, the KBRG-255 will vary the motor speed as a function of the voltage on input terminals "12" (signal) and "13" (common). **IMPORTANT: When J7 is set for speed control ("SPD"), J8 must be set to "S/LT" position (factory setting).** The input voltage can be derived from the wiper of the main speed potentiometer or from an *isolated* analog input (voltage following mode). Since the KBRG-255 is a 4-quadrant regenerative drive, the motor speed will follow both a positive and negative wiper voltage and drive the motor in both the forward direction and reverse direction. In addition, it will apply both forward and reverse torque in order to stabilize motor speed.

To understand the concept of a regenerative drive, the operation of an elevator can be used. If one were to enter the elevator on the first floor and press 10, the motor and control would have to lift the elevator against gravity. In this mode, the drive would operate like a conventional speed control which is called "motoring" (the applied load is opposite to the direction of motor rotation). When the elevator is at floor 10 and floor 1 is pressed, gravity will try to pull the elevator car down faster than the speed for which it is set. The control will then provide reverse torque to keep the car from falling faster than the set speed. This operation is regeneration (the applied load is in the same direction as the direction of motor rotation). Table 3 summarizes the different modes of regen operation.

**TABLE 3 – SUMMARY OF CONTROL OPERATION**

Quadrant	Type of Operation	Motor Rotation Direction	Motor Torque Direction	Applied Load Direction
I	Motoring	CW	CW	CCW
II	Regeneration	CCW	CW	CCW
III	Motoring	CCW	CCW	CW
IV	Regeneration	CW	CCW	CW

- B. Torque Control Mode** – When Jumper J7 is set to "TRQ" position, the KBRG-255 will vary motor torque. The KBRG-255 has been redesigned and now contains two (2) types of torque characteristics which are selectable with jumper J8. Speed/Linear Torque (S/LT) and Non Linear Torque (NLT). In the "S/LT" position (factory setting), both output torque and motor speed vary linearly as a function of the input signal. The "S/LT" type of torque is most suitable for take up and pay out winders where the speed and torque requirements vary as the winder roll diameter changes. The "S/LT" torque characteristics are shown in fig. 2A, p. 5.

In the "NLT" position, only torque (not speed) is varied by the input signal. The motor output torque remains constant over the motor's full speed range unless the load is less than the set torque. If the load torque decreases below the set torque, the motor will rapidly increase to full speed. This type of torque control is applicable to processes where the torque must remain constant over a wide motor speed range. The "NLT" torque characteristics are shown in fig. 2B, p. 6.

Because the KBRG-255 is a regenerative control, torque will be applied in both forward and reverse directions. The maximum torque can be set with the FWD CL and REV CL trimpots, and by using the FWD ACCEL and REV ACCEL trimpots, the rate of change of torque can be made more or less gradual. The maximum speed trimpot can be used to set the maximum motor speed under a no load condition.



FIG. 2A – LINEAR TORQUE CURVE

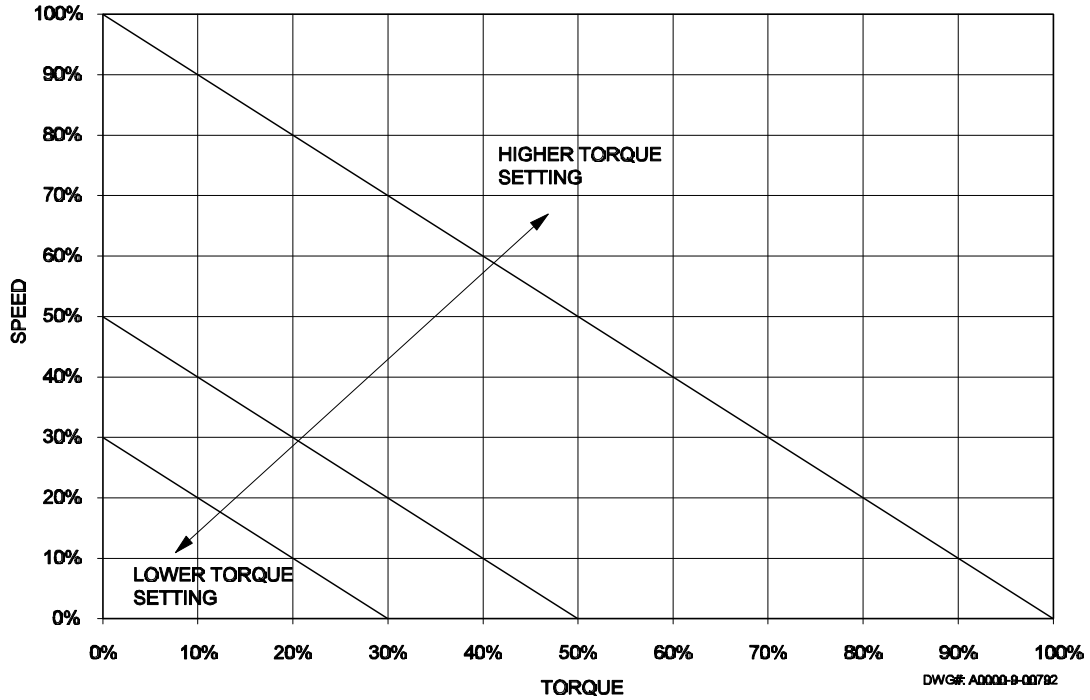
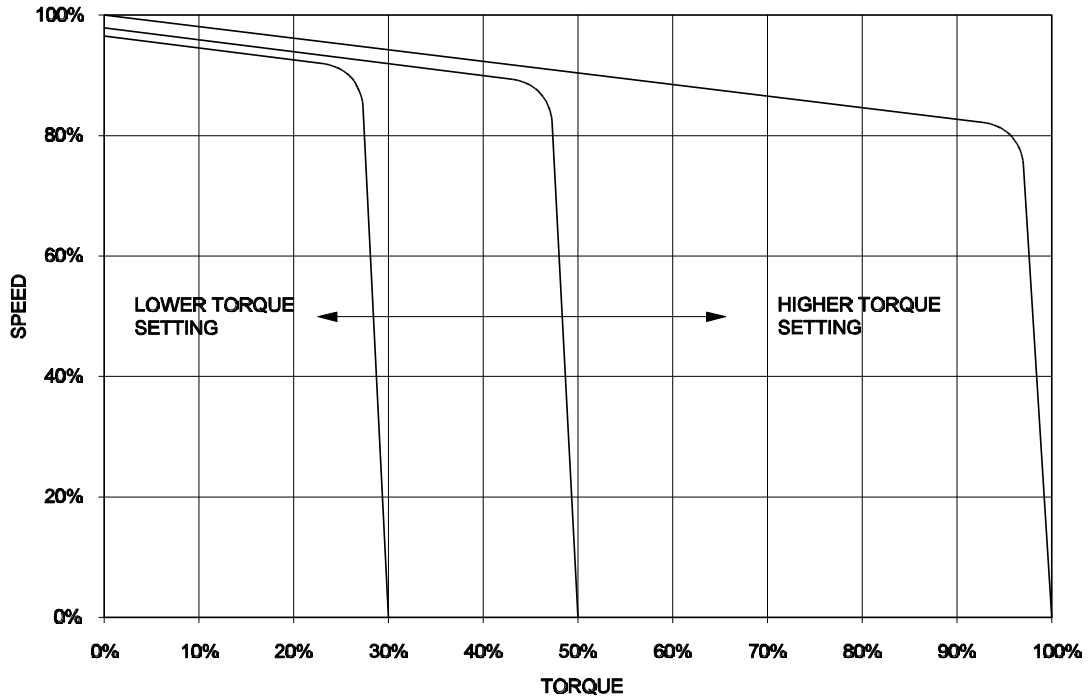

FIG. 2B – NON-LINEAR TORQUE CURVE



III. SETTING SELECTABLE JUMPERS.

The KBRG-255 has customer selectable jumpers which must be set before the control can be used (refer to fig. 1 p. 3). **Bold** indicates Factory Setting. (See sec. II, p. 4 for J7 and J8 settings.)

- A. **J4 - Tach-generator Voltage** – (Note: Selection of the jumper position is not required if armature feedback is used.) Place J4 jumper in the position "7V", "20/30V," **"50V"** that corresponds to the tach-generator voltage in Volts/KRPM. Note: The tach voltage jumper position is based on motor speed of 1,800 RPM.

For example, if the tach is 25V/KRPM and the motor speed is 3,600 RPM, use the "50V" J4 position. For other tach-generator voltages and motor speeds, an external resistor (RT) may be used as follows.

- i. Install resistor in series with either tach-generator lead.
- ii. Place J4 in "7V" position.
- iii. The value of RT is calculated as follows.

$RT = [(5.4 \times Vt \times S) - 68,000]$   
Choose the closest standard 1/2 watt resistor value to the calculated value

VT = Tach voltage in volts/1000 RPM  
S = Base Speed of motor in RPM

**B. J5 - Feedback Type** – The KBRG-255 can be operated in either armature feedback "AFB" or tach-generator feedback "TFB." Armature feedback provides adequate load regulation for most applications. For very precise performance, tach-generator feedback "TFB" should be used. (Note: If tach feedback is desired, an external DC tach-generator must be used and connected as per instructions.) (See section V J, p. 10 for tach-generator wiring.) (Note: The IR Comp trimpot must be set to the minimum setting [CCW] for tach feedback.)

**C. J6 - Current Limit (CL) Mode** – The KBRG-255 contains electronic current limiting that limits the maximum DC current to the motor. Two modes of current limit are provided:

- 1. Timed Current Limit "TCL" – Turns the drive off after a preset time. (The time period is adjustable with the TCL trimpot from 1-15 seconds and is factory set for approximately 5 seconds.) In order for the Timed CL feature to operate, the Start/Stop circuit must be wired. To restart drive after it has "timed out," the Start button must be pressed.

**Application Note:** The "TCL" feature cannot be used in either torque mode, since nuisance tripping will occur.

- 2. Non-Timed Current Limit "NTCL" – In this mode, the drive will reach preset Current Limit during overload and stay at that level until drive is turned "off" or fuse blows. If Non-Timed CL is desired, move jumper J6 from the factory set "TCL" position to the "NTCL" position.

#### IV. MOUNTING.

Mount the KBRG-255 in a vertical position (connection terminals in down or up position) on a flat surface free of moisture, metal chips, or corrosive atmosphere. (Note: If drive is mounted in other than a vertical position, decrease maximum allowable ambient temperature by 10 °C.) (See Mechanical Specification fig. 5, p. 8.) A 5K ohm Remote Speed potentiometer is provided with each control. Install potentiometer using hardware provided. Be sure to install insulating disk between potentiometer and inside of front panel.

**Enclosure** – When mounting the KBRG-255 in an enclosure, it must be large enough to allow for proper heat dissipation. A 18"x24"x36" enclosure is suitable for the KBRG-255 at full rating. Smaller enclosures may be used if full rating is not required.

#### V. WIRING. **Warning! Read Safety Warning before attempting to use this control.**

**Warning! To avoid erratic operation do not bundle AC Line and motor wires with potentiometer, voltage following, enable, inhibit or other signal wiring. Use shielded cables on all signal wiring over 12" (30 cm) – Do not ground shield.**

Wire control in accordance with National Electric Code requirements and other local codes that apply. Be sure to fuse each conductor which is not at ground potential (do not fuse neutral or grounded conductors). (See section VI, p. 10, for fuse information.) Wire control in accordance with connection diagrams (see figs. 3,4,6 & 7A-E). A separate AC line switch or contactor must be wired as a disconnect switch to control so that contacts open each ungrounded conductor. See table 4 p. 7 for terminal block wiring information.

**TABLE 4 – TERMINAL BLOCK WIRING INFORMATION**

Terminal Block Designation	Connection Designation	Supply Wire Gauge*		Maximum Tightening Torque (lb inch)
		Minimum	Maximum	
TB1 (Power Board)	F+, F-	22	14	7
TB1 (Logic Board)	Logic Connections	22	14	3.5
TB2	L1, L2, M1, M2	18	8	16

\*AWG, Cu wire only.

- A. **AC Line** – Connect AC line to terminals L1 and L2. (See fig 3.)
- B. **Ground** – Be sure to ground (earth) the control via green screw located on chassis
- C. **Motor Armature** – Connect motor armature to terminal M1 and M2. (See fig. 3)
- D. **Field** (For Shunt Wound motors only) – Do not use F+ and F- terminals for any other motor type. Connect motor shunt field to terminals F+ and F- for 180VDC motors with 200VDC fields. For motors with half voltage fields, 180VDC motors with 100VDC fields, connect field to terminals F+ and L1 (see fig 4A and 4B). See table 5 for summary of Field Connections.

**FIG. 3 – AC LINE AND ARMATURE VOLTAGE**

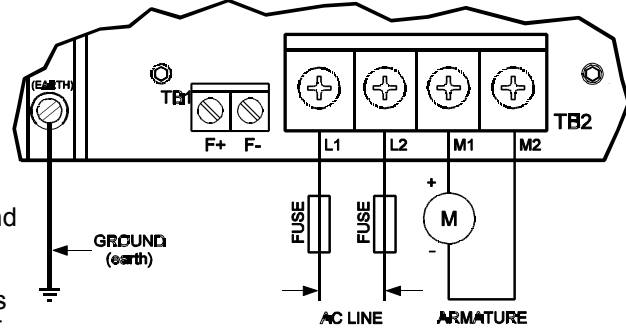

**CAUTION – Shunt-Wound motors may be damaged if field remains connected without motor rotating for an extended period of time. To remove field voltage from motor, disconnect AC line.**

**FIG. 4A – FULL VOLTAGE FIELD**

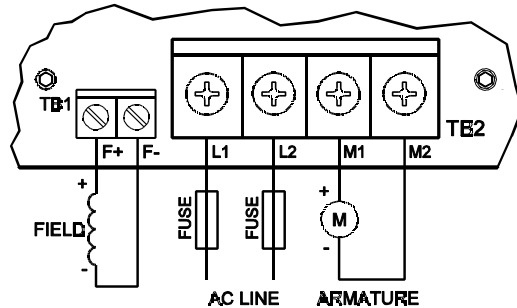

**FIG.4B – HALF VOLTAGE FIELD**

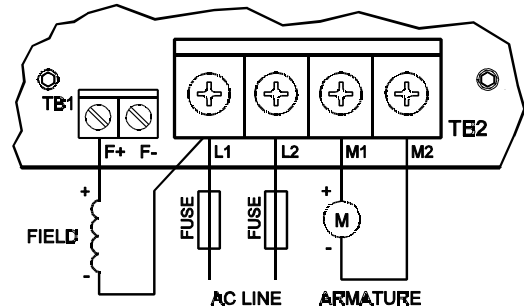
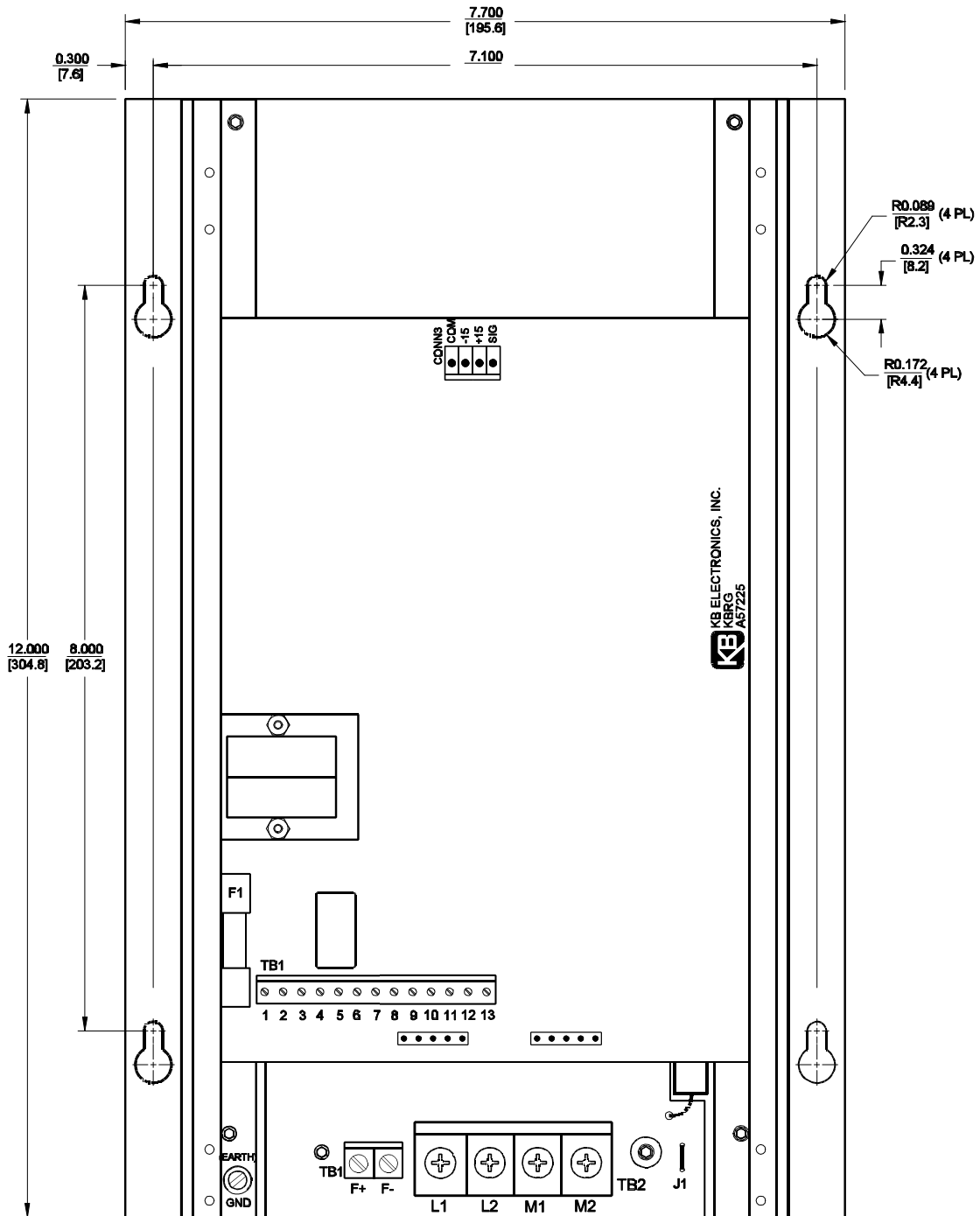

**TABLE 5 – FIELD CONNECTIONS (Shunt Wound Motors Only)**

AC Line Voltage (VAC)	Motor Voltage	Field Voltage (VDC)	Field Connection
230	180	200	F+, F-
230	180	100	F+, L1

- E. **Main Speed Potentiometer** – The main speed potentiometer can be connected in several ways using terminals "10," "11," "12" and "13." (A 5K ohm potentiometer is supplied with control. A 10K potentiometer can also be used.) **[WARNING: Terminals 10, 11, 12 and 13 are not isolated from AC line. Do not ground (earth).]**
  - i. Unidirectional operation only – Connect potentiometer to terminals "10," "12," "13" for forward direction. (To operate in reverse direction, connect to "11," "12," "13.")

FIG. 5 – MECHANICAL SPECIFICATIONS INCHES  
[mm]



NOTE: MAXIMUM HEIGHT IS 3.440 [87.4]

DWG#: D3800-1-00891

- ii. Bidirectional operation using reversing contacts – Connect to terminals "10," "11," "12," "13" as per fig. 6.
- iii. Bidirectional operation with potentiometer – Connect potentiometer to terminals "10," "11," "12" as per fig. 6.

**FIG. 6 – MAIN SPEED POTENTIOMETER CONNECTIONS**

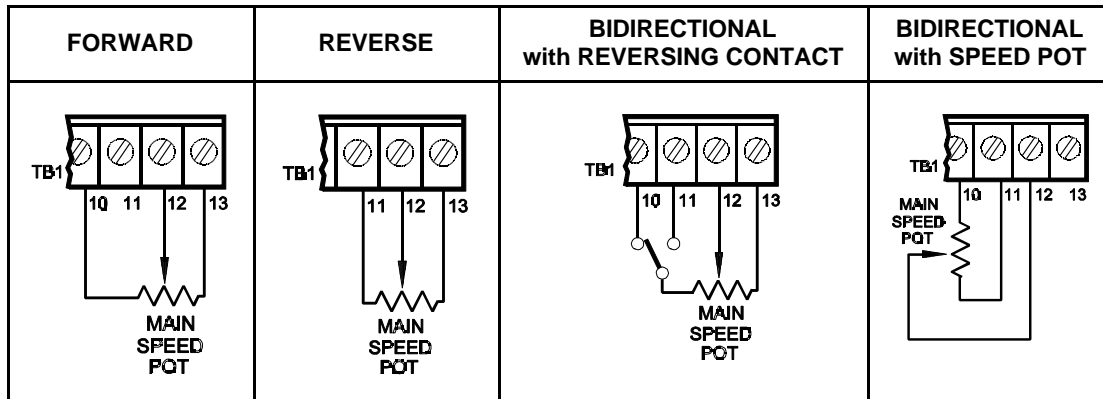

**F. Voltage Following** – An *isolated* analog voltage can be used in lieu of main speed potentiometer. Connect signal to terminals "12" and "13." Note: Terminal "13" is common. A positive signal with respect to terminal "13" will produce a positive output to motor. A negative signal with respect to terminal "13" will produce a negative output. A 0 to  $\pm 10$ VDC is required to operate control from 0 to  $\pm$  full output. **WARNING! Do not common multiple drives without a signal isolator.** A bipolar signal isolator, SI-4X (KB P/N 8801), is available as an option from your distributor. (See fig. 7A.)

**FIG. 7A – VOLTAGE FOLLOWING**

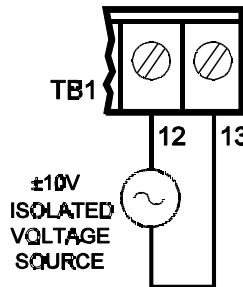

**G. Enable** – Control may be electronically started and stopped with Enable circuit. Connect Enable contacts between terminals "8" and "9." When terminals "8" and "9" are joined, control is in "ENABLE" state. When terminals "8" and "9" are open, control is in "INHIBIT" state. (See fig. 7B, p. 10.)

**IMPORTANT! If Enable is not used, a jumper must be installed between terminals "8" and "9" or control will not operate. (See Safety Warning on page 1.)**

**H. Start/Stop Circuit** – A standard 3-wire start/stop circuit is provided (terminals "5," "6" and "7"). This allows a remote momentary 2-button start/stop station to be installed. In this mode, if AC power is removed, the start button must be used to restart the control. Also, when the control is in the Timed Current Limit mode (J6 set to TCL) and has "timed out," it must be restarted using the start button. (See fig. 7C, p. 10)

**IMPORTANT! If the Start/Stop mode is not required, a jumper must be installed between terminals "5" and "7."**

(Note: The Timed CL function will operate only when the start/stop mode is used.) Control will not start using Start/Stop circuit if AC line voltage is below 20% of nominal (190V on 230V circuit). (See Safety Warning on page 1.)

**I. Alarm Contacts** – S.P.S.T. relay contacts (terminals "3" and "4") are used to signal a warning or to shut other equipment down if control goes to an Inhibit state. Rating of contacts are 1A-28VDC, .5A-115VAC. See table 6 for relay control state vs contact state. (See fig. 7D, p. 10.)

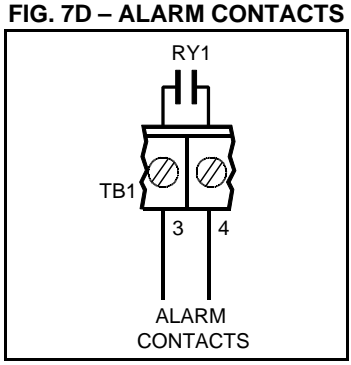
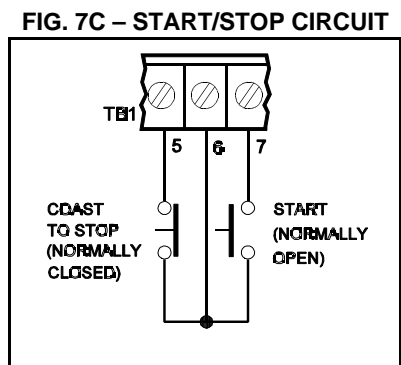
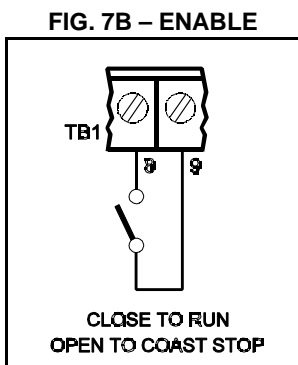
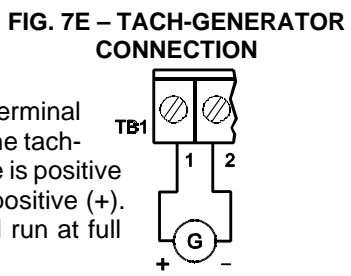

**TABLE 6 – CONTROL STATE vs RELAY CONTACT STATE**

Description of Control State	Relay Contact State	
	Using Start / Stop	Start / Stop Bypassed
No power to control	O	O
Power applied	O	X
Control in Stop mode	O	NA
Control is started with Start button	X	NA
Control has "Timed Out" in TCL	O	NA

O – Open, X – Closed, NA – Not Applicable

**J. Tach-generator Input** – Terminals "1" and "2" are used to connect a DC tach-generator and should be used only when control is in Tach-generator Feedback mode (J5 is in "TFB" position). Connect the positive (+) tach lead to terminal "1" and the negative (-) tach lead to terminal "2." Note: The tach-generator polarity must be phased so that the tach voltage is positive (+) on terminal "1" when the voltage on terminal "12" is positive (+). If the tach-generator is wired backwards, the control will run at full speed only.



**VI. FUSING.**

The logic control board contains a low amperage fuse (.150 amp Littelfuse 3AG normal blo or equivalent) which protects the control transformer and other components against catastrophic failure. Under normal circumstances, this fuse should never blow. (See fig. 1, p. 3, for location.)

The KBRG-255 does not contain AC line or armature fusing. It is recommended that a 40 Amp fuse or circuit breaker be installed on each AC line conductor not at ground potential. Do not fuse ground or neutral wires.

**VII. OPERATION.**

 **WARNING! Read Safety Warning on page 2 before attempting to operate or severe injury or death can result.**

After the KBRG-255 has been set up and the drive has been properly wired, the startup procedure can begin. Before initially starting, be sure main speed pot is in minimum position. (Set main speed pot to full CCW position if wired for unidirectional operation and to center position if wired for bidirectional control. (See fig. 6, p. 9.)

Start control by applying AC power. Enable circuit must be closed for control to start (jumper terminals "8" and "9"). If wired for start/stop operation, press start switch. If not wired for start/stop, terminals "5" and "7" must be jumpered. Rotate main speed potentiometer to control motor speed.

### VIII. TRIMPOT ADJUSTMENTS.

The KBRG-255 contains many trimpots which have been factory adjusted for most applications. (See table 2, p. 2. for factory settings.) (Note: fig. 1, p. 3 presents the various trimpots with their locations. They are shown in the approximate adjustment position.) Some applications may require readjustment of trimpots in order to tailor control to exact requirements. Readjust trimpots as follows:

#### A. Forward Acceleration (FWD ACCEL) and Reverse Acceleration (REV ACCEL) –

The FWD ACCEL trimpot determines the amount of time it takes the control voltage to reach full output in the forward direction. It also determines the amount of time it takes for the control voltage, in the reverse direction, to reach zero output. (FWD ACCEL also sets the Reverse Decel.)

The REV ACCEL trimpot determines the amount of time it takes the control voltage to reach full output in the reverse direction and the time it takes for the control voltage, in the forward direction, to reach zero output. (REV ACCEL is the Forward Decel.)

The FWD and REV ACCEL trimpots are factory adjusted to 1 second. The acceleration times are adjustable to a maximum of 15 seconds. (See fig. 8 for graphic representation of ACCEL.)

**Note:** The FWD and REV CL trimpots settings may override the rapid accel and decel settings.

**Note:** A 4-quadrant ACCEL/ DECEL accessory module is available as an option. It provides separate control of FORWARD acceleration and deceleration and REVERSE acceleration and deceleration.

#### B. Offset (OFFSET) – This trimpot determines the amount of bias in the forward or reverse direction. The trimpot is factory set to provide approximately zero offset, which means neither the forward nor the reverse speed is favored. (See fig. 9 which illustrates the action of the OFFSET trimpot.)

FIG. 8 – ACCEL TRIMPOT ADJUSTMENT

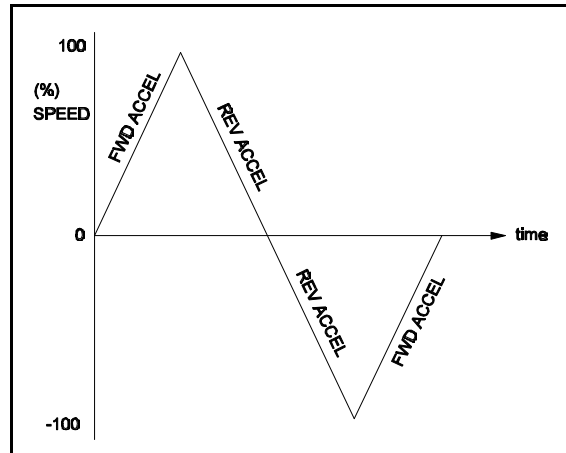

FIG. 9 – OFFSET TRIMPOT ADJUSTMENT

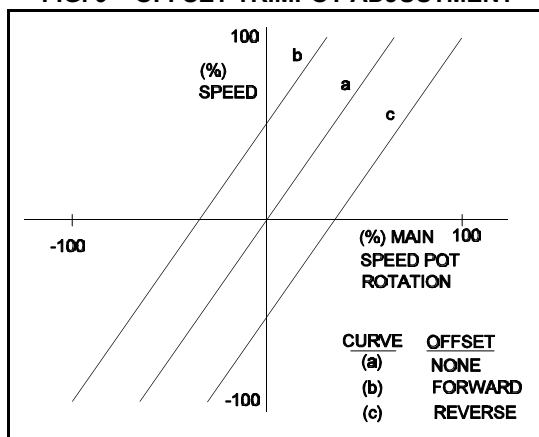
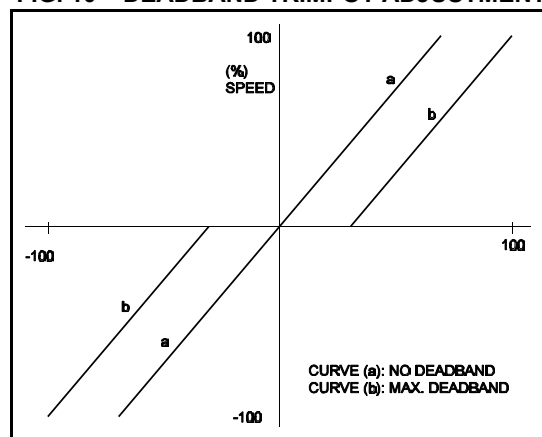

FIG. 10 – DEADBAND TRIMPOT ADJUSTMENT



- C. Deadband (DB)** – The DB trimpot sets the amount of main speed potentiometer rotation required to initiate control voltage output. It is factory adjusted to approximately 25% of rotation.

The DB trimpot also determines the amount of delay that will occur before regeneration starts. (Regeneration occurs when the applied load torque is in the same direction as the motor rotation.)

To readjust the DB to factory setting:

- i. Set Main Speed pot to zero speed position.
- ii. Set DB trimpot to full CCW position.
- iii. Adjust DB trimpot CW until motor hum is eliminated.

(See fig. 10, p. 11 for graphic illustration of the DB trimpot.)

Note: If the deadband trimpot is set too low (CCW direction), the motor may oscillate between forward and reverse. Adjust deadband trimpot CW until the instability disappears. (Oscillation may also occur due to response setting. See section VIII, G, p. 13.)

- D. Forward Current Limit (FWD CL) and Reverse Current Limit (REV CL) Trimpots** – These trimpots are used to set the maximum amount of DC current that the motor can draw in both the forward and reverse directions. The amount of DC current determines the amount of maximum motor torque in both the Speed Control Mode and Torque Control Mode. They are factory set at 150% of the rated current (38.0 ADC).

Readjust the CL trimpots as follows:

- i. Turn CL trimpot to MIN (CCW) position.
- ii. Wire in a DC ammeter in series with armature lead. Lock shaft of motor.
- iii. Apply power. Rotate CL trimpot CW until desired CL setting is reached (factory setting is 1.5 times rated motor current). Be sure control is in Forward direction for FWD CL trimpot adjustment and likewise with REV CL.

**WARNING! Do not leave motor shaft locked for more than 2 – 3 seconds to prevent motor damage.**

**CAUTION: Adjusting the CL above 150% of motor rating can cause overheating and demagnetization of some PM motors. Consult motor manufacturer.**

- E. IR Compensation (IR Comp)** – The IR Comp is used to stabilize motor speed under varying loads. (Note: If control is in Tach Feedback mode, the IR Comp should be set to minimum - CCW.)

Readjust the IR Comp trimpot as follows:

- i. Run motor at approximately 30-50% of rated speed under no load and measure actual speed.
- ii. Load motor to rated current. Rotate IR Comp trimpot so that loaded speed is the same as the unloaded speed measured in the previous step.

Control is now compensated so that minimal speed change will occur over a wide range of motor load. [Note: Too much IR Comp will cause unstable (oscillatory) operation.]

- F. Maximum Speed (MAX)** – The MAX trimpot is used to set the maximum output voltage of the control which, in turn, sets the maximum speed of the motor. In the Torque Control Mode, the MAX trimpot setting determines the unloaded motor speed.

Adjust the MAX trimpot as follows:

- i. Rotate Main Speed potentiometer to full speed (CW).
- ii. Adjust MAX trimpot to desired maximum motor speed.

(Note: Do not exceed maximum rated RPM of motor since unstable operation may result.)



- G. **Response (RESP) Trimpot** – This trimpot determines the dynamic response of the control. The factory setting is approximately 50% of full rotation. The setting may be increased if a faster response is required. (Note: If response is made too fast, unstable operation may result.)
- H. **Timed Current Limit (TCL) Trimpot** – Trimpot is functional only when control is wired for 3-wire Start/Stop and J6 is in the TCL position. The TCL trimpot sets the delay time for the Timed Current Limit. The trimpot is adjustable over a time range of 1-15 seconds and is factory set for approximately 5 seconds. Calibrate the TCL trimpot by setting the trimpot to the approximate desired delay time as follows: (See table 7.)

**TABLE 7 – CURRENT LIMIT TIMER SETTINGS**

<b>Approx. Trip Time (Secs)</b>	<b>Trimpot Position</b>
1	Full CCW
8	Midway
15	Full CW

**IX. FUNCTION INDICATOR LAMPS.**

- A. **LED 1 Power On (PWR ON)** – Indicates that the drive is energized with the AC line.
- B. **LED 2 Current Limit (CL)** – Indicates that the drive is in Current Limit. If set in the timed Current Limit mode (J6 set to "TCL") and has "timed out," the LED 2 will remain ON until the drive is restarted.
- C. **LED 3 Forward Enable (FWD EN)** – Indicates that the drive is engaged in the forward direction. [Enable circuit closed (terminals "8" and "9" joined), the start circuit initiated and a "forward" speed command.] The FWD EN lamp will also be lighted in the reverse direction if the control is in regeneration.
- D. **LED 4 Reverse Enable (REV EN)** – Indicates that the drive is engaged in the reverse direction. [Enable circuit closed (terminals "8" and "9" joined), the start circuit initiated and a "reverse" speed command.] The REV EN lamp will also be lighted in the forward direction if the control is in regeneration.

### **X – LIMITED WARRANTY**

For a period of 18 months from date of original purchase, KB will repair or replace without charge devices which our examination proves to be defective in material or workmanship. This warranty is valid if the unit has not been tampered with by unauthorized persons, misused, abused, or improperly installed and has been used in accordance with the instructions and/or ratings supplied. The foregoing is in lieu of any other warranty or guarantee, expressed or implied, and we are not responsible for any expense, including installation and removal, inconvenience, or consequential damage, including injury to any person, caused by items of our manufacture or sale. Some states do not allow certain exclusions or limitations found in this warranty so that they may not apply to you. In any event, KB's total liability, under all circumstances, shall not exceed the full purchase price of this unit. (rev 4/88)



**KB ELECTRONICS, INC.**

12095 NW 39th Street, Coral Springs, FL 33065 • (954) 346-4900 • Fax (954) 346-3377

Outside Florida Call **TOLL FREE** (800) 221-6570 • **E-mail** – [info@kbelectronics.com](mailto:info@kbelectronics.com)

[www.kbelectronics.com](http://www.kbelectronics.com)

(A40287) – Rev. B – 2/99